

MP3000

High-Power FM/AM/CD/MP3 Receiver with Detachable Face
Autoradio FM/AM à Lecteur CD/MP3 de Forte Puissance et à Face Amovible
Receptor FM/AM/Reproductor de CD/MP3 de Alta Potencia y con Panel Extraíble
Rádio FM/AM/CD/MP3 de Alta Potência com Face Removível

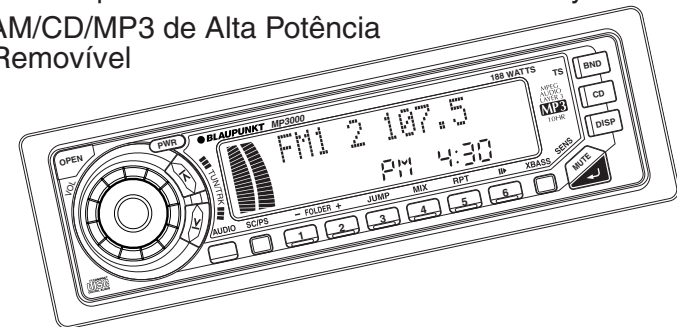

Important Notice
Prior to Installation, "Demo Mode" should be defeated.
See page 7.

Robert Bosch Corporation
Sales Group —
Blaupunkt Division
2800 South 25th Avenue,
Broadview, Illinois 60155

BLAUPUNKT
Bosch Group

FCC WARNING

This equipment has been tested and found to comply with the limits for a Class B device, pursuant to Part 15 of the FCC Rules. These limits are designed to provide reasonable protection against harmful interference in a residential installation. This equipment generates, uses, and can radiate radio frequency energy, and if not installed and used in accordance with instructions, may cause harmful interference with radio communications. However, there is no guarantee that interference will not occur in particular installations. If this equipment does cause harmful interference to radio or television reception, which can be determined by turning the equipment off and on, the user is encouraged to consult the dealer or an experienced radio/TV technician for help. You are cautioned that any changes or modifications not expressly approved in this manual could void your authority to operate this equipment.

Features

- **MP3/WMA file playback support**
- **CD-TEXT support (SONG, ALBUM)**
- **Detachable flip down front panel**
- **Built-in power amplifier (max. output : 47W × 4ch)**
- **FM/AM PLL Synthesizer tuner**
- **30 Station preset memory**
- **Travel Store / Scan tuning**
- **X-BASS System**
- **Station / Disc name store, Station / Disc call**
- **Auxiliary input**

Precautions

- Avoid installing the unit where it would be subject to high temperatures, such as in direct sunlight or a hot air stream from the heater, or where it would be subject to dust, dirt, or excessive vibration.
- Do not turn on the unit if the temperature inside the car is very high. Always cool down the unit before usage. Park your car in direct sunlight will result in a temperature rise.
- If the unit does not turn on, check the connections first. Then check whether the fuse at the back of the unit is blown.
- Carefully read this manual before using the unit. If you encounter any problems that are not covered in this manual, please consult the dealer where you purchased the unit or the dealer nearest to you.
- This unit has been designed specifically for playback of compact discs bearing the following mark. Other discs cannot be played.



Handling Compact Discs

- Be careful when removing a compact disc after the playback is completed because the disc may be extremely hot.
- Do not use non-conventional discs such as heart-shaped, octagonal discs, etc. The player could be damaged.
- Do not expose compact discs to direct sunlight or any heat source.
- Check a compact disc before playing, and discard cracked, scratched or warped discs.
- Wipe dirty or damp discs outward from the center with a soft cloth.
- Do not use any solvents such as commercial available cleaners, antistatic spray, or thinner to clean the compact discs.
- If a label is affixed to a disc, the label may prevent removal of the disc from the unit or may damage the unit.

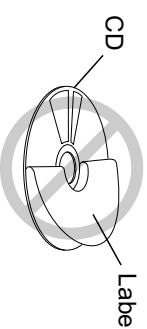
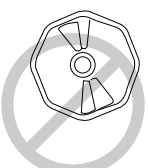
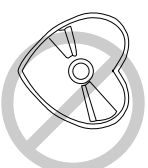
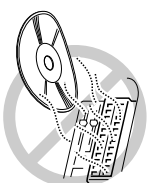
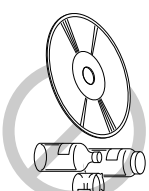
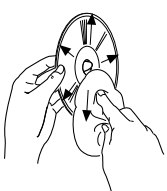

Handling the Front Panel

Attaching the Front Panel

Place the right hand side of the front panel so that the parts ① of the front panel are engaged with the parts ② of the unit as shown below. Then push the left hand side of the front panel until it is securely locked.

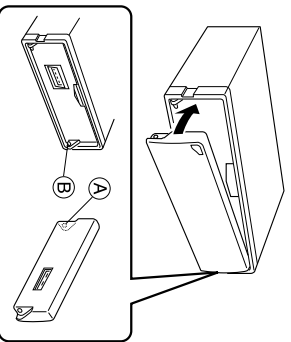

Front Panel Open / Close

Panel open

Press the **OPEN**.

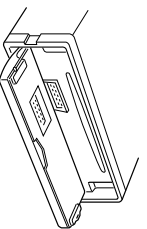

Panel close

Raise the front panel with your finger until it locks in place.

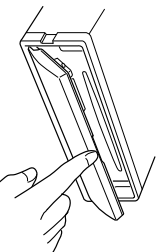

Detaching the Front Panel

1. Press the **OPEN** firmly to open the flip down front panel.



2. Pull the front panel toward your direction to remove it.

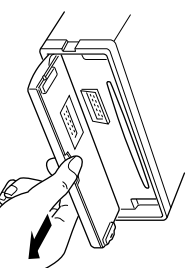

3. Close the inner cover.

Do not leave inner cover in the down position unless the front panel is in place.

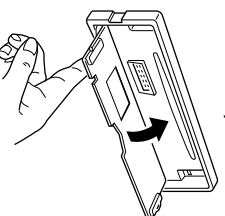

Notes

- Be sure to use this unit with the front panel closed. The unit is automatically switched off when the front panel is left open for about 10 minutes.
- Do not handle the unit roughly when opening/closing the front panel.
- Do not put any object or use it like a tray when the front panel is open in a lying position.
- Do not press **OPEN** button when closing the front panel.
- Do not put too much force to the operation buttons or the display window as it may cause damage or deform the unit.
- Connectors on the unit and front panel are vital parts transmitting the signal. Do not touch, push or scratch them.
- Be careful not to pinch your fingers or hands when opening and closing the front panel.
- Do not press hard on the front panel when affixing it to the unit. No more than light to moderate pressure should be needed.
- Make sure there is no dust or dirt on the electrical terminals on the back of the front panel as this could cause intermittent operation or other malfunctions.

Security/Retailer Display

Bolt the front panel with the locking screw (See page 16) in the inner cover as shown below, to protect the front panel from theft and from getting lost.

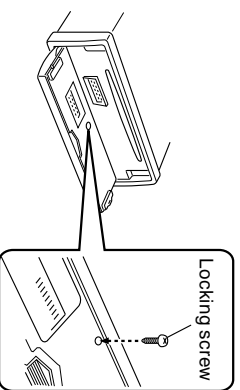

Ejecting the CD

Press the recessed button located to the left behind the Front Panel.

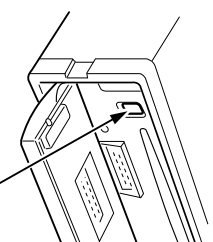

EJECT button

Identification of Controls

Front Panel

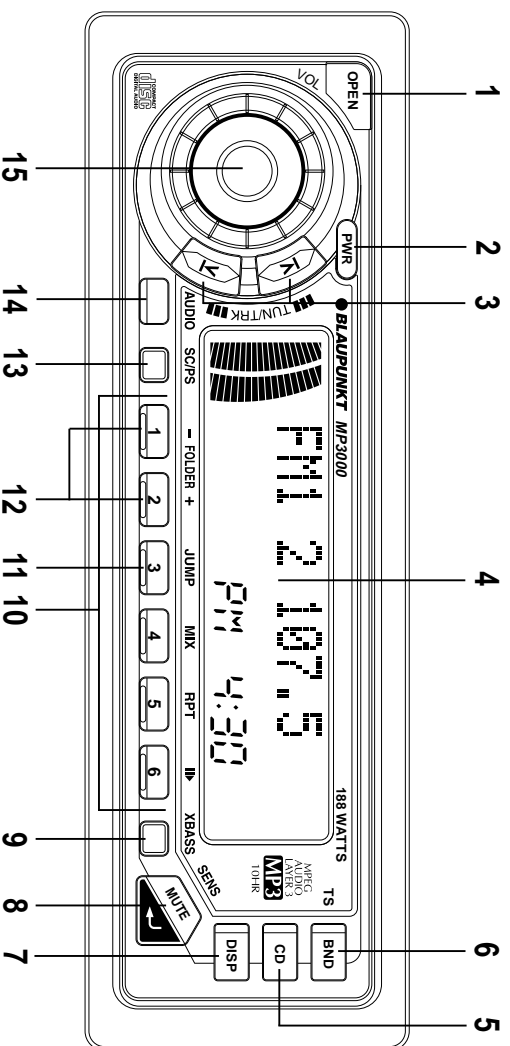

- 1 OPEN button**
Open the flip down front panel.
- 2 PWR button**
Turns the power of the unit on or off.
- 3 TUN/TRK button**
Used to tune in to the desired station.
- 4 LCD Display window**
- 5 CD button**
Select the operating source (CD, CD changer or AUX).
- 6 BND/T.S button**
Selects the AM/FM Band & Travel store.
- 7 DISP button**
Mode selector. Clock adjustment. Display priority setting.
- 8 MUTE/SENS button**
Muting the sound. Switches the seek sensitivity between local and distance.
- 9 XBASS button**
Boosts the bass sound.
- 10 PRESET MEMORY button**
During radio reception :
 (1) - (6) ; For Preset memory
 During CD mode :
 (4/MIX) ; For Mix play (Mix & Mix all during CDC)
 (5/RPT) ; For Repeat play
 (6/▶) ; For Pause

- 11 JUMP button**
If an ID3 Tag has been recorded on MP3 file, one touch switches the unit to ID3 Tag display. (Not supported with WMA.)
- 12 FOLDER SELECT button**
Select the desired CD in CDC (CD changer) mode. Select the desired FOLDER in MP3/WMA play mode.
- 13 SCPS button**
Scan tuning. Preset scan tuning. Scan play in CD/CDC mode.
- 14 AUDIO button**
Audio control selector; Bass, Treble, Loudness, Balance & Fader.
- 15 Dial**
Adjusts the volume level/bass/treble/balance/fader. Used to store the station names, and selects alpha-numeric characters.

LCD Display

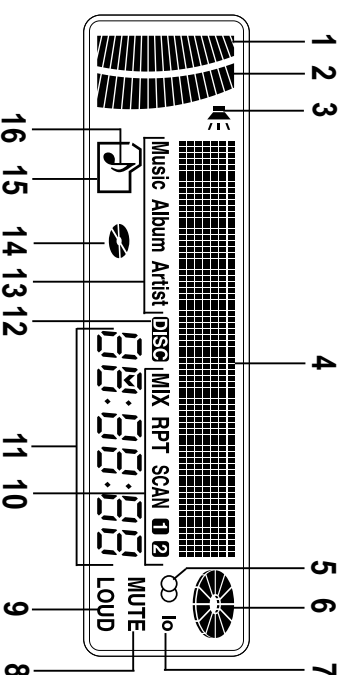

- 1 L-ch Level Meter**
- 2 R-ch Level Meter**
- 3 XBASS indicator**
- 4 Main display section**
- 5 STEREO signal indicator**
- 6 Signal-strength indicator**
- 7 lo(Local) indicator**
- 8 MUTE indicator**
- 9 LOUD indicator**
- 10 MIX/RPT/SCAN Mode indicator**
- 11 Clock indicator**
- 12 CD Changer indicator**
- 13 ID-3-Tag indicator**
- 14 DISC IN indicator**
- 15 FOLDER indicator**
Flashes when the folder name is displayed.
- 16 FILE indicator**
Flashes when the file name is displayed.

General Operations

Turning the power On/Off

Press the **[PWR]** to turn on or off the unit.

Tip

When you turn on the unit, **"BLAUPUNKT MP3 - I WANT MY MP3"** will be displayed before actual power on.

When you turn off the unit, **"BYE - BYE"** will be displayed before actual power off.

You can edit these message. (See **"Turn on/off message edit"**)

Volume Level Control and Memory

Rotate the dial to adjust the volume.

It is also possible to set the maximum volume when the power is switched on by following the procedure explained below.

1. Turn the dial until it is set at the required volume.



2. Press the **[PWR]** for two or more seconds. The power will be switched off and the Turn-On volume level is saved.

Muting the sound

Press **[MUTE/SENS]**.
"MUTE" appears on the display window.

To restore the previous volume level, press **[MUTE/SENS]** again.

Setting the Clock

The clock uses a 12-hour display system. (factory set)

1. Turn the ignition key to the ON position.
2. Press the **[PWR]** to turn on the unit.
3. Repeatedly press the **[DISP]** to display "CLOCK 12".
4. Rotate the dial within 5 seconds to select the 12 or 24-hour time mode. Each time you rotate the dial, the mode changes or toggles as follows :



5. Repeatedly press the **[DISP]** to display "CLOCK ADJUST".
 - A. Press the **[MUTE/SENS]** within 5 seconds to flash the hour digit.
 - B. Rotate the dial to set the hour digit.
 - C. Press the **[MUTE/SENS]** to flash the minute digit.
 - D. Rotate the dial to set the minute digit.
6. Press the **[DISP]** momentarily to complete the Clock setting mode.

Note

If you make no button input or dial operation in 20 seconds, the Clock setting mode will turn off automatically.

Ignition-off Clock Recall

The display will illuminate showing the time and then automatically shut off after 5 seconds.

Press the **[DISP]** while the ignition switch is in the "OFF" position.

Adjusting the Sound Characteristics

1. Press the **[AUDIO]** to select the desired adjustment mode as follows:



2. Rotate the dial to adjust the selected item.
 Adjust within 3 seconds after selecting the item. After 3 seconds, the dial reverts to volume control. Use the following tables as a guide for adjusting the settings in each mode.



Adjustment Range

BASS	BASS -5	BASS +5
TREBLE	TREBLE -5	TREBLE +5
LOUDNESS	LOUD OFF	LOUD ON
BALANCE	L9 R0 (Full left)	L0 R9 (Full right)
FADER	R9 F0 (Full rear)	R0 F9 (Full front)

Tip

Settings for BASS, TREBLE, LOUDNESS and XBASS can be made to each of the following modes independently: FM, AM, CD, MP3, CD Changer and AUX.

Switching the Source (Selecting auxiliary input)

You can connect the auxiliary equipment (Portable cassette player, etc.) to this radio via optional AUX-IN cable. (See page 17) Each time the **CD** is pressed, the operation source will change over as shown below;

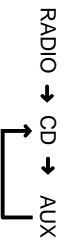

Press the **BND/TS** to return to radio mode.

Note

If the **CD** button is pressed when no CD has been loaded into the unit, The CD mode will skip to the AUX mode.

Mode Selector

Each time the **DISP** is pressed, the display window will change over as shown below;

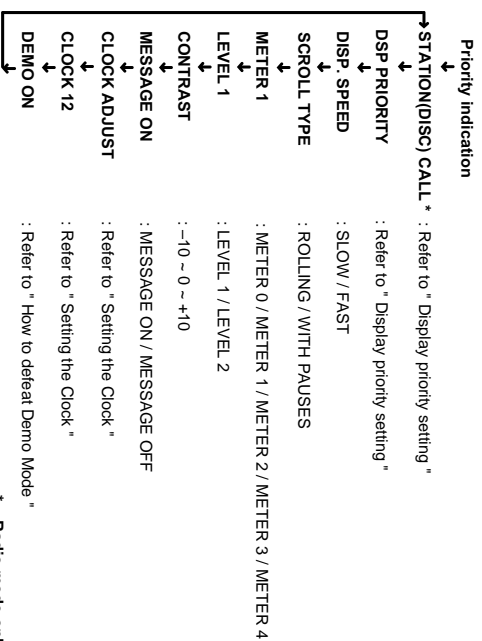

Notes

- "STATION CALL" and "DSP priority" are not displayed in AUX mode.
- If you make no button input or dial operation in few seconds, the display returns priority indication.

Display priority setting

Example
To set Station Name to the Display Priority.

1. Repeatedly press the **DISP** to display "DSP PRIORITY" appears in the display window.
2. Rotate the dial to select "STATION NAME" or "FREQUENCY".
3. Hold the **DISP** pressed for more than 2 seconds to confirm/enter your selection.
"NO NAME" or a previously assigned station name (See page 10) flashes once to indicate that Station Name is selected for the Display Priority.
After 5 seconds, the display mode will automatically return to the Display Priority showing either "NO NAME" or the station name.

Tip

Frequency Display is initially set to the Display Priority, and Station Name ("NO NAME") is set to the "Temporary" indicator.

Display Priority can be set for the following items;

- Radio mode ↔ Station name
- CD or other media

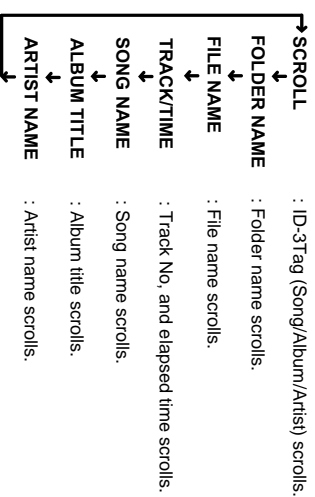

The items supported for display priority for each media are as shown in the table below.

When an item that is not supported is selected, "NO NAME" is displayed, following which TRACK/TIME is displayed.

Media	CD	CD TEXT	MP3	WMA
DISP Priority				
ID3-Tag Scroll		X ^{*1}	X ^{*2}	
FOLDER NAME			X	X
FILE NAME			X	X
TRACK/TIME	X	X	X	X
ID3-Tag MUSIC		X	X	
ID3-Tag ALBUM		X	X	
ID3-Tag ARTIST			X	

Notes

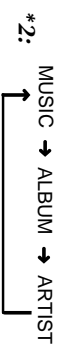
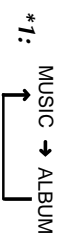

Display Speed selection

The scroll speed of the display indication can be switched.

You can select :

- SLOW : Slow.
- FAST : Fast.

1. Repeatedly press the **[DISP]** to display the "DISP. SPEED" on the display window.
2. Rotate the dial to select the desired display speed.



Display Scroll type selection

The scroll type of the display indication can be switched.

You can select :

- ROLLING : Scrolls across the display.
- WITH PAUSES : Scrolls across the display with pause.

1. Repeatedly press the **[DISP]** to display the "SCROLL TYPE" on the display window.
2. Rotate the dial to select the desired scroll type.



Level Meter selection

The meter displays can be selected from four types.

You can select :

- METER 1 : The level meter goes upward.
- METER 2 : Only the very top segment lights.
- METER 3 : The remaining segments light. (opposite of METER 2)
- METER 4 : The level meter goes up and down dividing from the center segment.
- METER 0 : No meter is indicated.

1. Repeatedly press the **[DISP]** to display the "METER 1" on the display window.
2. Rotate the dial in a clockwise direction to select the desired meter indication.



Level Meter Sensitivity selection

The sensitivity of the level meter display can be switched.

You can select :

- LEVEL 1 : Normal sensitivity.
- LEVEL 2 : High sensitivity.

1. Repeatedly press the **[DISP]** to display the "LEVEL 1" on the display window.
2. Rotate the dial to select the desired meter sensitivity.



Display Contrast selection

The contrast of the display can be adjusted.

You can adjust :

- -10 ~ 0 ~ +10

1. Repeatedly press the **(DISP)** to display the "CONTRAST" on the display window.
2. Rotate the dial to select the desired display contrast.



Message ON/OFF selection

Message display following POWER ON/OFF can be switched.

You can adjust :

- MESSAGE ON : A message is displayed following power on/off.
- MESSAGE OFF : No message is displayed.

1. Repeatedly press the **(DISP)** to display the "MESSAGE ON" on the display window.
2. Rotate the dial to select whether or not to display a message following power on/off.



How to defeat Demo Mode

After installation we recommend defeating the Demo Mode.

When power is turned off, the unit switches to demonstration mode.

The demonstration starts about 10 seconds after power off.

The demonstration of each function is repeatedly shown on the display screen.

You can adjust :

- DEMO ON : The demonstration is displayed after power off.
- DEMO OFF : A demonstration is not displayed after power off.

1. Repeatedly press the **(DISP)** to display the "DEMO ON".
2. Rotate the dial to select whether or not the demonstration should be displayed when power is off.



Enhancing the bass sound

For extended bass centered @ 72Hz, Blaupunkt's XBASS function can be set for either each band and CD/MP3/CDC/AUX mode.

You can select :

- XBASS 1 : Enhanced BASS level (low).
- XBASS 2 : Enhanced BASS level (Middle).
- XBASS 3 : Enhanced BASS level (High).
- XBASS 4 : Enhanced BASS level (Very high).
- XBASS 0 : No BASS enhanced.

Press the **(XBASS)** repeatedly to select the bass sound.

"**⏮**" appears on the display window. (Except for XBASS 0) Each time you press **(XBASS)**, the current mode appears on the display window and the mode change as follows:

XBASS 0 → XBASS 1 → XBASS 2 → XBASS 3 → XBASS 4

Note

Reduce XBASS level if your combination of speakers and add-on amplifiers sound distorted at the preferred sound level.

Turn on/off message edit

You can edit the turn on/off message and store it in memory. Following four messages can be edit with 12 characters each. When you turn on the unit, "MESSAGE 1" will be displayed then "MESSAGE 2" will momentarily displayed before actual power on.

When you turn off the unit, "MESSAGE 3" will be displayed then "MESSAGE 4" will momentarily displayed before actual power off.

Turn-on message

- MESSAGE 1 / MESSAGE 2

Turn-off message

- MESSAGE 3 / MESSAGE 4

1. Repeatedly press the **(DISP)** to display the "MESSAGE ON" on the display window.
2. Press the **(MUTE/SENS)** to flash the "MESSAGE 1".
3. Rotate the dial to select the desired message you want to edit.
MESSAGE 1 → MESSAGE 2 → MESSAGE 3 → MESSAGE 4
4. Press the **(MUTE/SENS)**, then enter the character.
 - A. Rotate the dial in a clockwise direction to select the desired characters.
(A~Z, a~z, 0~9, () * + , - . / ! " # \$ % & ' : ; < = > ? @ [\] ^ _ ` { | } ~)
 - B. Press the **(TUN/TRK ▲)** to move the flashing cursor to the next position. If you press **(TUN/TRK ▼)**, the flashing cursor moves to the left.
 - C. Repeat steps A. and B. to complete entering the entire message 12 characters max.

Tips

- To erase/correct a message, press the **(DISP)** for more than 2 seconds to clear the character and re-enter.
- When entering a name, pressing the following buttons affects the display of characters as follows:

1. Changes to inputting letters. (Starts with "A".)
If pressed while letters are already selected, switches between upper and lower case letters.
2. Changes to inputting numbers. (Starts with "0".)
3. Changes to inputting symbols. (Starts with ".".)
6. Enters a space (blank).

5. Press the **(MUTE/SENS)** to store the message.
The new message flashes.

6. To return to the normal radio reception, Press **(DISP)**.

Notes

- If you make no button input or dial operation in 20 seconds, the message edit mode will turn off automatically.
- Make sure the "MESSAGE" will be "ON".

Erasing the turn on/off message

You can erase the turn on/off message if so desired.

1. Repeatedly press the **(DISP)** to display the "MESSAGE ON" on the display window.
2. Press the **(MUTE/SENS)** to flash the message you edit.
3. Rotate the dial to select the desired message you want to erase.
4. Press the **(DISP)** for more than 2 seconds.
Repeat steps 1. and 3. if you want to erase other message.
5. To return to the normal radio reception, Press **(DISP)**.

Radio Reception

Seek Tuning

1. Press the **[BND/TS]** to select the desired AM or FM band. FM1 → FM2 → FMT → AM → AMT (FMT & AMT are Travel Store bands.)
2. Press the **[TUN/TRK]** to tune in stations. Tuning automatically stops at a broadcasting frequency. When tuned in to FM stereo broadcasting stations, the "OD" stereo signal indicator will appear on the display window.

Manual Tuning

1. Press the **[BND/TS]** to select the desired AM or FM band.
2. Press the **[TUN/TRK]** or **[TUN/TRK]** for more than 0.5 second to activate the manual tuning mode. Press again to tune in to stations. "MAN" will appear on the display window. After 4 seconds of completing Manual Tuning, the tuning control will revert to the Seek Tuning mode.

Scan Tuning

1. Press the **[BND/TS]** to select the desired AM or FM band.
2. Hold the **[SCPS]** pressed for less than 2 seconds. The unit will scan the selected band for stations. "SCAN" indicator will appear on the display window. The unit will stop at each station for 8 seconds, before continuing to the next station. Press the **[SCPS]** again to stop Scan Tuning and remain this on the selected frequency.

Tip

While tuning, the pie-shaped signal-strength meter  on the display is lit differently depending on the strength of the signal. While scanning bands, the pie-shaped signal-strength meter spins. While playing CD's, this display also spins.

Preset Scan Tuning

1. Press the **[BND/TS]** to select the desired AM or FM band.
2. Hold the **[SCPS]** pressed for more than 2 seconds. "SCAN" indicator will appear on the display window. The unit will scan preset memory for the 12 stations from the AM/AMT band or the 18 stations from the FM1/FM2/FMT bands. The unit will stop at each preset station for 8 seconds, before continuing to the next preset station. Press the **[SCPS]** again to stop Preset Scan Tuning and remain this on the selected frequency.

Memorizing Stations Automatically (Travel Store)

1. Press the **[BND/TS]** to select the desired AM or FM band.
2. Hold the **[BND/TS]** pressed for longer than 2 seconds. Up to 6 stations with strong signals will be automatically stored in preset memory for the selected band. If the radio is in FM1 or FM2, it switches to FMT. If the radio is in AM, it switches to AMT.

Note

This function is available for FMT and AMT.

Memorizing Only the Desired Stations

You can store up to 6 stations on each band (18 for FM1, FM2 and FMT, 12 for AM and AMT) in the order of your choice.

1. Press the **[BND/TS]** to select the desired band.
2. Press the **[TUN/TRK]** to tune in stations.
3. Press and hold the desired preset memory button **[1-6]** for about 2 seconds until the frequency indicator flashes twice. The number of the pressed preset memory button appears on the display window.

Note

If when you store another station on the same preset number button, the previously stored station is replaced with new one.

Receiving the Memorized Stations

1. Press the **[BND/TS]** to select the desired AM or FM band.
2. Press the **[1-6]** momentarily.

Local/Distant (LO/DX) Selection

This feature is used to select the signal strength at which the radio will stop during Seek Tuning.

Press the **[MUTE/SENS]** for more than 2 seconds to select the Local setting and only strong (local) stations will be received. The "lo" indicator appears on the display window. Pressing for more than 2 seconds again will select the Distant setting and the radio will stop at a wider range of signals, including weaker more distant stations. The "lo" indicator will go out on the display window. DX is the suggested default setting.

Storing the station names

You can assign a name to each radio station and store it in memory. As much as 30 station names can be stored composed with 12 characters each.

Storing the station names

1. Tune in a station whose name you want to store.
2. Press the **[DISP]** for more than 2 seconds. The "NAME EDIT" will light then the " _ " on the display window. The first " _ " flashes.

3. Enter the characters.

- A. Rotate the dial in a clockwise direction to select the desired characters.
(A~Z, a~z, 0~9, () * +, - . / ! " # \$ % & ' ; : < = > ? @ [\] ^ _ ` { | } ~)
- B. Press the **[TUN/TRK ▲]** to move the flashing cursor to the next position. If you press **[TUN/TRK ▼]**, the flashing cursor moves to the left.
- C. Repeat steps A. and B. to complete entering the entire name 12 characters max.

Tips

- To erase/correct a name, press the **[DISP]** for more than 2 seconds to clear the character and re-enter.
- When entering a name, pressing the following buttons affects the display of characters as follows:
 - 1 : Changes to inputting letters. (Starts with "A.")
If pressed while letters are already selected, switches between upper and lower case letters.
 - 2 : Changes to inputting numbers. (Starts with "0".)
 - 3 : Changes to inputting symbols. (Starts with "(".)
 - 6 : Enters a space (blank).

4. Press the **[MUTE/SENS]** to store the station name. The station name flashes.
5. To return to the normal radio reception, Press **[DISP]**.

Note

If you try to store more than 30 station names, "*****FULL*****" will be displayed.

Erasing the station names

1. Tune in any station and press the **[DISP]** for more than 2 seconds.
2. Press the **[MUTE/SENS]**. The station name or " _ " flashes.
3. Rotate the dial to select the name of the station that you want to erase. To erase all the names of the stations, display "*****ALL DELETE*****".
4. Press the **[DISP]** for more than 2 seconds. Repeat steps 3. and 4. if you want to erase other names.
5. To return to the normal radio reception, Press **[DISP]**.

Direct Access to Memorized Stations via Station call

You can search for the memorized AM & FM station names in the memory.

1. Press the **[DISP]** to display the "STATION CALL" on the display window.
2. Rotate the large dial to select the desired station name.
3. Press the **[MUTE/SENS]** to tune in the desired station.

CD Operations

Playing the CD player

Loading Discs

1. Press the **OPEN** and insert the disc.
2. Close the front panel. "LOADING" and "FILE CHECK" will appear in the display window. Playback begins automatically.

Note

Make sure that the front panel is closed when playback begins.

Playback with the front panel open causes the unit to turn off automatically in about 10 minutes.

Labeled side up

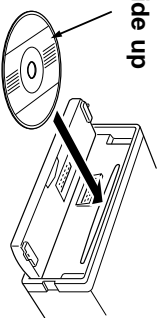

I NEVER Insert a 3-inch CD!

This unit is designed for playback of standard 5-inch CD's only. Do not attempt to use 3-inch CD singles in this unit, either with or without an adaptor, as damage to the player and/or disc may occur.

Tips

- When a CD is loaded, the  on the display remains lit.
- During playback of a CD, the pie-shaped signal-strength meter  spins.

Listening to a disc that is already loaded

Press the **CD** to select the CD mode. Playback begins automatically.

Pausing Playback

Press the **STOP**.
To resume playback, press the **STOP** again.

Stopping Playback

Press the **BAND/TS** to select the radio reception (FM1, FM2, FMT or AM, AMT).

Ejecting Discs

Press the **CD** to eject the disc located behind flip-down front panel.

Notes

- The unit will turn on automatically when a CD is inserted if the ignition switch is "ON".
- When the disc is ejected from the CD slot, remove it within 10 seconds; otherwise, the disc will be reloaded automatically.

Track Search

Press the **TUN/TRK** during CD mode. Track numbers appear in the display window.

- ▶** : Playback starts from the beginning of the next track.
- ◀** : Playback starts from the beginning of the current track. Press again to play the previous track.

Cue / Review

Press and hold the **TUN/TRK**. Release when you have found the desired point.

- ▶** : To search forward.
- ◀** : To search backward.

Scan Play

Press the **SC/PS** during CD mode.
The "SCAN 1" indicator appears in the display window. This will play the first 10 seconds of all the tracks on the disc. Press the **SC/PS** again to cancel this feature.

Repeat Play

Press the **S/RPT** during CD mode.
The "RPT 1" indicator appears in the display window and the current track is played repeatedly.
Press the **S/RPT** again to cancel this feature.

Mix Play

Press the **4/MIX** during CD mode.
The "MIX 1" indicator appears in the display window.
All the tracks on the current disc are played in random order. Press the **4/MIX** again to cancel this feature.

Note

If the Mix, Repeat or Scan buttons are pressed for 2 seconds or longer while playing a music CD, the unit will enter the respective mode2. These modes can be used for playing MP3 discs which contain a number of folders. (See page 12.)
Since a music CD is treated as a folder, there is almost no difference in the operation.

MP3 / WMA operation

You can play MP3 and WMA files written on CD-ROMs, CD-Rs, or CD-RWs by following the procedures below. In this section, "track" and "album" mean "MP3 or WMA file" and "folder" in PC terminology, respectively.

MP3 / WMA play

Loading Discs

1. Press the **OPEN** and insert a CD-ROM, CD-R, or CD-RW with the labeled side upward.
2. Close the front panel.
During scanning of the disc, "LOADING" and "FILE CHECK" appear in the display window. Playback begins automatically. CD-R/RW with very complex folder trees could take in the range of 20-seconds to load.

Listening to a disc that is already loaded

Press the **CD** to select the CD mode. Playback begins automatically.

Pausing Playback

Press the **PAUSE**.
To resume playback, press the **PAUSE** again.

Stopping Playback

Press the **BAND/TS** to select the radio reception (FM 1, FM 2, FT or AM, AT).

Ejecting Discs

Press the **EJECT** to eject the disc located behind the flip-down front panel.

Notes

- The unit will turn on automatically when a CD is inserted if the ignition switch is "ON".
- When the disc is ejected from the CD slot, remove it within 10 seconds; otherwise, the disc will be reloaded automatically.
- ID3 Tags are not supported for WMA files.

Track Search

Press the **TUN/TRK** during CD mode. Track numbers appear in the display window.

- ▶** : Playback starts from the beginning of the next track.
- ◀** : Playback starts from the beginning of the current track. Press again to play the previous track.

Album(Folder) Search

Press the **FOLDER+** or **FOLDER-** during CD mode. Folder indicator " " flashes in the display window.

- FOLDER+** : Playback starts from the beginning of the next folder.
- FOLDER-** : Playback starts from the beginning of the previous folder.

Cue / Review

Press and hold the **TUN/TRK**. Release when you have found the desired point.

- ▶** : To search forward.
- ◀** : To search backward.

Scan / Folder Scan Play

Scan Play (Mode1)

Press the **SC/PS** during CD mode.
The "SCAN 1 ON" appears in the display window. This will play the first 10 seconds of all the tracks on the disc. Press the **SC/PS** again to cancel this feature.

Folder Scan Play (Mode2)

Press the **SC/PS** for more than 2 seconds during CD mode. The "SCAN 2 ON" appears in the display window. This will play the first 10 seconds of first tracks in each folder. Press the **SC/PS** again to cancel this feature.

Repeat / Folder Repeat Play

Repeat Play (Mode1)

Press the **SRPT** during CD mode.
The "RPT 1 ON" appears in the display window and the current track is played repeatedly. Press the **SRPT** again to cancel this feature.

Folder Repeat Play (Mode2)

Press the **SRPT** for more than 2 seconds during CD mode. The "RPT 2 ON" appears in the display window and the current folder is played repeatedly. Press the **SRPT** again to cancel this feature.

Mix Play / Folder Mix

Mix Play (Mode1)

Press the **4MIX** during CD mode.
The "MIX 1 ON" appears in the display window. All the tracks on the current folder are played in random order. Press the **4MIX** again to cancel this feature.

Folder Mix Play (Mode2)

Press the **4MIX** for more than 2 seconds during CD mode. The "MIX 2 ON" appears in the display window. All the tracks on the current disc are played in random order. Press the **4MIX** again to cancel this feature.

ID3 Tag Jump

When a file containing an ID3 Tag is played, pressing **3JUMP** immediately switches the unit to ID3 Tag scroll display. When the scroll display finishes, the original display is restored. When pressed **3JUMP** while scroll display has priority, the original display is restored after displaying "TRACKTIME" for five seconds.

Tip

When playing a file that does not contain an ID3 Tag or when playing a WMA file, pressing **3JUMP** causes "NO NAME" to be displayed.

MP3 / WMA Overview

This unit can play back files recorded in MP3 or WMA format on CD-ROM, CD-R (recordable) or CD-RW (rewritable) discs. There are some limitations on the files and media that can be used, so before recording files on a disc please carefully read the following information.

ISO9660 Format

The unit can play back data recorded in ISO9660 format. ISO9660 is an international standard for representative CD-ROM file formats determined by ISO (International Standard Organization).

The media formats that can be used by the unit include Level 1, Level 2 and the extension format known as Joliet.

What are MP3 and WMA?

- An MP3 file stores audio data compressed using the "MPEG 1 / 2 audio layer-3" file format. We call files that have the ".mp3" extension "MP3 files". Likewise for WMA files. WMA is an abbreviation for Windows Media Audio. WMA files have the extension ".wma" and are compatible with MP3 files.
- The unit cannot read files that have a file extension different from ".mp3" or ".wma".
- The unit cannot read files without an extension even if the files are MP3 or WMA files.
- Furthermore even if a file has an ".mp3" or ".wma" extension, the unit cannot read the file if it is not recorded with the MP3 or WMA data format.

Playback Limitations

- The number of tracks and number of albums (folder) that can be played back from a disc are as follows.
Tracks : About 250 depending on file contents.
Albums(folder) : A maximum of 250 depending on the number of tracks.
- The unit also recognizes up to eight album(folder) levels.
- The unit can playback MP3 files with compression bit rates from 32kbps~320kbps. However for the best balance of file space and sound quality we recommend 128kbps. When files compressed at less than 128kbps are played back, the sound may have breaks in it.

Sampling rates are supported as follows.

MPEG 1	48K	44.1K	32K
MPEG 2	24K	22.05K	16K
MPEG 2.5	12K	11.03K	8K

In the case of WMA files, playback is possible only for files encoded with a compression bit rate of at least 64kbps and a sampling rate of 44.1 KHz.

- Please note that the unit cannot play files encoded using the WMA copyright protection function.
- When playing WMA files, song, album and artist tags cannot be displayed.
- The unit allows the playback of CD-R and CD-RW discs containing a mixture of music CD data (CD-DA), MP3 and WMA files. However playback of both types of data is possible only for Mixed Mode CDs/CD Extra created using Disc at Once Method. (See below.)
- The unit also supports files compressed using VBR (variable bit rate).
- The unit does not always playback MP3 and WMA files in the order in which they were recorded.
- When many folders are recorded on a disc, the time required to retrieve information from the disc becomes longer.
- We recommend that multi-session discs be limited to 10 sessions.

The packet write method is not supported.

The following three methods are used to record data (files) on a disc. As the unit does not support the "Packet Write" method please be aware of this.

The unit supports discs recorded with the "Disc at Once" and "Track at Once" methods.

Disc at Once Method

With this method, all the data to be written is prepared in advance and then recorded on the disc in one go. Additional writing of data is not possible.

Track at Once Method

With this method, data is written in file (track) units. Additional writing of data is possible.

Packet Write Method

With this method, tracks are sub-divided into packets depending on availability of space on the disc. Additional writing of data is possible.

Display Information Limitations

- The unit can display folder and file names. ID3 Tags of length up to 64 characters including the extension. However, certain special symbols may not display correctly.
- During playback of MP3 and WMA files, there may be occasions when the elapsed playback time is not correctly displayed.

Important Points

- Please take care not to append the extensions for MP3 and WMA files onto files of any other type. When a disc containing such files is played, the files will be incorrectly recognized and played back. This will result in extremely loud noise that may damage the speakers.
- Depending on the state of the disc or recorder or writing software used to write on the disc, there may be cases when the disc cannot be correctly played back. In such cases please refer to the user manual for the tools you are using.
- When using a Macintosh personal computer, the file extension will not be added, so please add the extension ".mp3" to the end of the file name.
- This unit does not support WAVE files.
- This unit does not support m3u playlists.
- The unit does not support "Emphasis". (See "Glossary" on page 15.)

Note Concerning Bit Rate and Record Time

Please refer to the following general guide concerning the bit rate used when encoding and the overall time of a file recorded on disc.

Before recording on a disc, please carefully read the software instructions and ensure you use it correctly.

Note

When the sampling frequency used for encoding is 44.1KHz

For highest sound quality	320kbps	About 4hr
CD quality (High sound quality)	192 kbpps	About 7hr
CD quality (Medium sound quality)	160 kbpps	About 8hr
CD quality (Standard)	128 kbpps	About 10hr

When Creating Discs

Files will not always be played back in the order in which they were recorded. When you want to ensure that files will be played back in the order they were recorded, please write onto the disc paying attention to the points below.

- Use writing software that can write MP3/WMA files on the disc in the order of the file (track) names. Please check with the software developers concerning the behavior and operation of the writing software.
- Prefix numbers to the names of folders (albums) and files (tracks) to arrange them in order. Shown below is a good example (2 or three digits correctly entered,) and a bad example (if the number of digits is not the same for all names, the names will not be ordered correctly.)

Example

```
<good>
01XXXXX.mp3
02XXXXX.mp3
03XXXXX.mp3
04XXXXX.mp3

<bad>
1XXXXX.mp3
10XXXXX.mp3
11XXXXX.mp3
2XXXXX.mp3
```

About Recommended CD-R and CD-RW Media

With some CD-R and CD-RW media, data may not be properly written depending on their manufacturing quality. In this case, data may not also be reproduced correctly. We recommend the media manufactured by the following companies:

CD-R Media

TDK USA Corp., Taiyo Yuden (U.S.A.), Inc., Ricoh Corporation, Eastman Kodak Company, Maxell Corporation of America, Mitsubishi Chemical Corporation, Fuji Photo Film U.S.A., Inc., Mitsui Chemicals, Inc., Sony Corporation of America, Philips Electronics North America Corporation, Imation Corp.

CD-RW Media

TDK USA Corp., Ricoh Corporation, Mitsubishi Chemical Corporation

Several types of CD-R and CD-RW media are available, such as 2X and 1X-4X. Please read the instruction manuals of the drive and the recording software you are using to select the right media.

Glossary

Bit rate

The bit rate expresses the amount of information transferred per second as a number of bits. The greater the quantity of information, the higher the bit rate.

The unit is "bits/second". "kbps" indicates "kilo (1,000) bits/second".

Emphasis

The software used for recording has an "emphasis" capability, which when turned on writes emphasis attributes on to the audio track. When the emphasis bit is set the sound has a smooth characteristic. However, at the current time almost all CD players lack support for this function. It is no problem to play back an audio track recorded with emphasis on with a player not supporting emphasis.

Extension

In Windows and DOS personal computers, several characters are placed at the end of each file name to indicate the type of file.

The extension consists of a period followed by three alphanumeric characters. The extension differs depending on file type. The extension for MP3 files is ".mp3".

ID3 Tags

This is a data format that allows a file name, title and artist name etc. to be added to MP3 files.

This unit supports SONG ALBUM and ARTIST for Versions 1.0/1.1/2.2 and 2.3.

ID3 Tags are not supported for WMA files.

Multi-Session

When data is written on a CD-R disc, the data written from the time writing starts until the time writing finishes is regarded as a bundle called a session. The Track at Once Method allows data to be added to a single disc one track at a time, with each recording of a track being a single session.

The term multisession refers to the method of recording the data for two or more sessions on a single disc. We recommend that this unit be used for up to 10 sessions.

Structure of Folder Hierarchy

To keep data within a computer organized, related files may be put into a folder, but in addition to files, a folder may also have other folders put into it. Folder B may be put into folder A, and folder C may be put into folder B so as to create a "hierarchical structure". The number of hierarchical levels that can be recognized differs depending on the computer operating system. ISO9660 specifies up to 8 levels.

VBR (Variable Bit Rate)

MP3 files are normally encoded with a fixed bit rate (eg 128kbps etc.), however VBR encoding during which the bit rate is varied while encoding is also possible. That is to say, during periods of violent variation of sound the bit rate is increased and during soundless periods the bit rate is decreased. Encoding in this way allows file size to be curbed while maintaining high sound quality. However, some players do not support VBR, so caution is required when using VBR.

Types of CD

• Audio CD(CD-DA)

This is the format used for audio CDs that can be played on ordinary audio CD players. It is also called CD-DA (Compact Disc Digital Audio).

• ISO9660 Format CD-ROM

ISO9660 is a CD-ROM standard file system determined by ISO (International Organization for Standardization). CD-ROMs with this format can be played by Windows and Macintosh operating systems and also by UNIX operating systems.

• HFS Format CD-ROM

This is a CD-ROM conforming to the HFS (Hierarchical File System) used by Macintosh Mac OS.

• Hybrid CD-ROM

This is a CD-ROM containing a mixture of ISO9660 format files and HFS format files.

• Mixed Mode CD

This is a CD-ROM containing both data files and audio files on the one disc.

Mixed Mode CD is a standard developed for personal computer use so the audio files on the CD cannot be played with CD players that do not support Mixed Mode CD.

• CD Extra (Enhanced CD)

This differs from Mixed Mode CD in that the audio files are followed on the disc by data files. CD Extra was standardized by Sony and Philips to allow the audio files to be played with an audio CD player and the data files to be read by a personal computer.

Installations

ENGLISH

Supplied Mounting Hardware

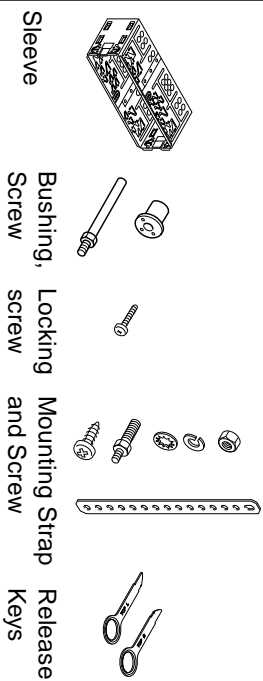

Precautions

- Be sure to detach the front panel before you start installing the unit.
- Choose the mounting location carefully so that the unit will not interfere with the normal driving operations of the driver.
- Use only the supplied mounting hardware for a safe and secure installation.
- When mounting the unit in a car, keep the unit as level as possible. If the unit must be mounted at an angle, due to the design of the vehicle, make sure that the unit does not tilt upward by more than 30°.
- Turn-off Demo mode before use.

Mounting Example

Installation in the dashboard.

1. Install the sleeve in the dashboard.

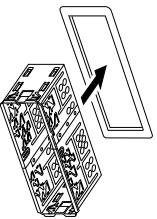

2. Select and bend the appropriate tabs to hold the sleeve firmly in place.

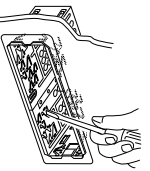

Mounting Strap Use

3. Attaching the Mounting Strap to the underside of the dash board, using screw. Attach the back of the unit to the Mounting Strap using the support stem bolt and hardware.

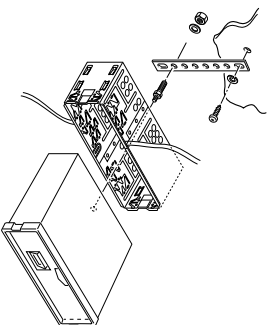

Bushing Use

3. As shown in the figure below, securely fasten the screw, which has been inserted into the bushing to the rear of the set.

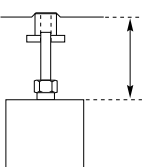
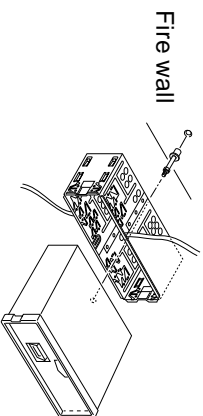

The distance to the fire wall varies due to the type of the car. Be sure to secure the unit by properly inserting the bushing.

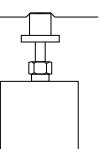

Caution
Insufficient fastening of the screw may cause some CD's to skip.

If your car has no accessory position on the ignition key switch (POWER SELECT switch)

The illumination on the front panel is factory-set to be turned on even when the unit is not being played. However, this setting may cause some car battery wear if your car has no accessory position on the ignition key switch. To avoid this battery wear, set the POWER SELECT switch located on the bottom of the unit to the **B** position, then press the RESET button. The illumination is reset to stay off while the unit is not being played.

Reset button
Press the reset button with the point of a sharp object such as a ball-point pen.

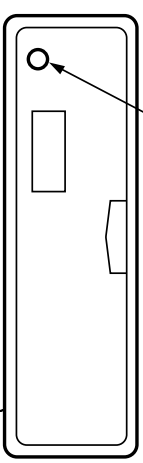

POWER SELECT SWITCH (Located on the bottom of the unit)

- Change the position with a jeweler's screwdriver, etc.
- Ⓐ : Your car has an accessory position on the ignition switch.
 - Ⓑ : Your car has no accessory position on the ignition switch.
- Be sure to press the reset button after changing the switch and connecting the lines.

Note

If set to the **B** position, demonstration mode will be eliminated.

Connections

Warning

- To prevent short circuit, remove the key from the ignition and disconnect the battery's (-) terminal.
- This unit is designed for negative ground 12 V DC operation only. You can not use it for 24 V or other types of car batteries.

Connection procedure

Caution

- DO NOT connect any speaker wires to the metal body or chassis of the vehicle.
- DO NOT connect the speaker common (-) wires to each other.
- Connect each speaker wire directly to each speaker terminal.
- All speaker common (-) wires must remain floating.
- No common connections or connection to vehicle grd.
- Connect each pair of speaker leads only to a single speaker (or speaker system) that has an Impedance of least 4 ohms, as well as 47-watt power-handling capability.
- Do not connect speaker leads to any inputs on external amplifiers. This will cause damage to the internal amplifier of this unit.

- 1 Make sure the car's ignition key has been removed.
- 2 Disconnect the negative (-) terminal of the car's battery.
- 3 Connect the wiring harness wires in the following order : Ground wire (Black), +12V Constant Power Supply (Yellow), +12V Accessory/Switched (Red) and Power Antenna/Amplifier Turn On (Blue), and tape each so they do not come in contact with each other.
- 4 Connect the speaker wires of the wiring harness.
- 5 Connect the car's antenna terminal to the antenna socket of the unit.
- 6 Connect the detachable wire harness to the unit.
- 7 Reconnect the negative (-) terminal of the car's battery.
- 8 Start the car's engine.
- 9 Make sure the unit operates properly.
- 10 Defeat Demo mode. (See page 7.)

Connection procedure

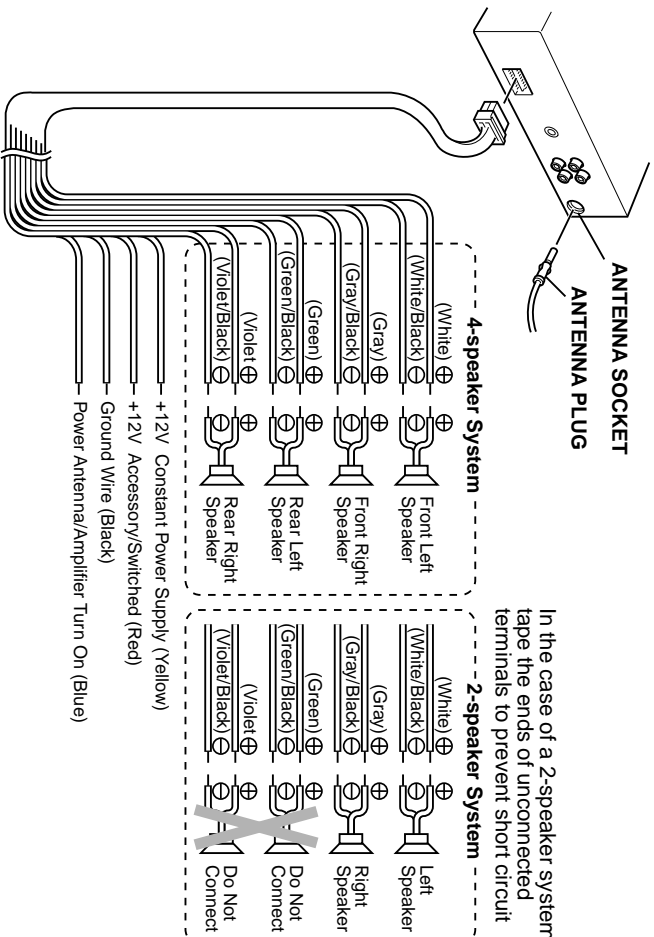

Preamp Out/AUX IN Connections

- Since this unit has Line Level Outputs, you can use an amplifier to upgrade your vehicle stereo system.

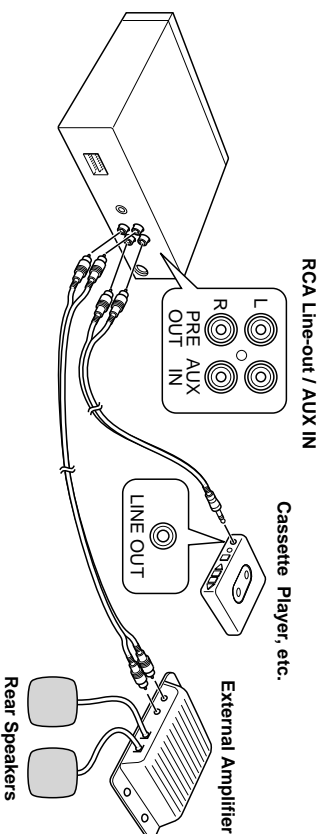

RCA Line-out Jacks

- Connect a patch cable (not supplied) from the White and Red RCA line output jacks of the unit to the line input terminals of the external amplifier.

Maintenance

Replacing the Fuse

If the fuse is blown, check the power connection first and then replace the fuse. If the fuse blows again under normal conditions, the unit may be defective.

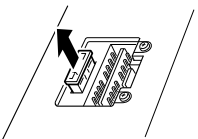

Back of the unit

Warning

Use only a fuse with the specified amperage (10 A). Use of another type of fuse can result in a fire or unit damage.

Cleaning the Connectors

If the connectors of the unit and the front panel are contaminated, malfunctions may occur. Detach the front panel and clean the connectors with an alcohol dampened cotton swab as shown below.

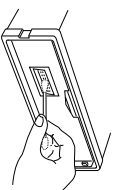

Main unit

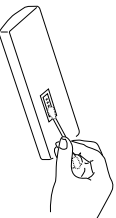

Back of the front panel

Returning to the Initial Settings

When the reset button is pressed, the microcomputer of the unit returns to the initial settings. If the display window is not properly shown or the unit malfunctions, press the reset button with the point of a sharp object such as a ball-point pen.

Note

- Remember to defeat Demo mode. (See page 7.)

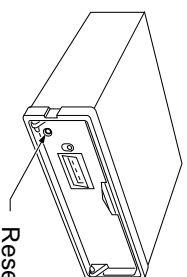

Reset button

Removing the Unit

Use the supplied release keys when you need to remove the unit from the car. Insert the "TOP R" and "TOP L" of the release keys on the right and left position until it clicks respectively, to remove the unit.

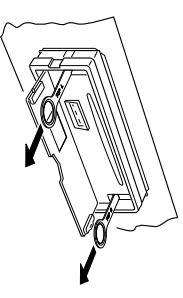
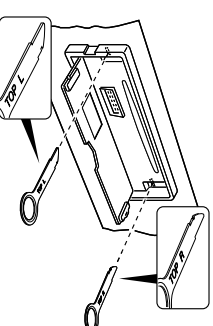

As shown in the figure below, push the plate spring firmly to remove the release keys.

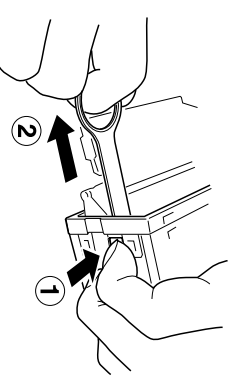

Notes

- Handle the release keys carefully to avoid injuring your fingers.
- Keep the release keys in a safe place for future use.

Troubleshooting Guide

The following check will assist in the correction of most problems which you may encounter with your unit. Before going through the check list below, refer back to the connection and operating procedures.

General

Trouble	Cause/Solution
<ul style="list-style-type: none"> • Memorized stations and correct time are erased. • The fuse has blown. • Radio works when the ignition key is the ON, ACC and OFF positions. 	Leads are not matched correctly with the car's accessory power connector. Check wiring for short circuits.
<ul style="list-style-type: none"> • No power is being supplied to the unit. • The power is continuously supplied to the unit. 	The car doesn't have an ACC position.

Radio reception

Trouble	Cause/Solution
Preset stations are not receivable.	The broadcast signal is too weak.
Seek tuning is not possible.	The broadcast signal is too weak. → Use manual tuning.
Travel Store feature does not complete storing of six stations.	Not enough broadcast frequencies are receivable.

Also make sure that antenna is connected, extended and dry inside.

If the above mentioned solutions do not help to improve the situation, consult your nearest **Blaupunkt** dealer or in the United States call 1-800-266-2528 for technical assistance, parts and service. Call 1-800-950-2528 for dealer referral or to request product brochure.

MP3 File Play Troubleshooting

Trouble	Cause/Solution
MP3 Files cannot be played.	<ul style="list-style-type: none"> • Write MP3 files with the extension ".mp3" to disc. • Ensure that files other than MP3 files do not have the extension ".mp3". • Use discs conforming to ISO9660 level 1/2. • Confirm that the disc is not scratched or dirty, and that it is not upside down.

Folder Name/File Name is not correctly displayed.

- Use a disc conforming to ISO9660 level 1/2.
- The name contains characters that could not be handled by the software used to write the files. Refer to the instruction manual for the software and use only characters that can be handled by the software.

ID3-Tag is not displayed.

- Record conforming with ID3-Tag v1.0/1.1/2.2 or 2.3.

Time elapses before an MP3 file is played.

- As this unit initially checks all files on the disc, some time may be required before it can start playing a file if the disc contains many files or folders or many folder levels.

MP3 files are not played in order.

- The files were not written by the write software in the desired playback order.
- Prefix digits such as "00" ... "99" to the file names. For details refer to the instruction manual for the write software.

CD Player Troubleshooting

When problems occur with CD playback, an error message appears in the display window.

Refer to the table below to identify the problem, then take the suggested corrective action. If the "SLED ERROR" appears, return unit to your nearest **Blaupunkt** dealer.

Message	Possible cause	Recommended action
LD/EJ ERROR	Loading/eject error.	Press the EJECT button and then reinsert the disc.
SERVO ERROR	Mechanical error.	Eject and then reinsert the disc.
TOC ERROR	The disc is dirty, reversed or not recorded etc.	Check the disc and replace with a proper disc.
FILE ERROR	File read failure.	Reinsert the disc. The disc does not contain music files or the file extensions are missing. Add the extension ".mp3" or ".wma".
COMM ERROR	Communication error.	Reinsert the disc.

- When the disc can not be inserted, press the EJECT button (See page 2.) and try inserting the disc again. Alternatively, press the Reset button (See page 18.) and try inserting the disc again.
- If the disc does not eject after the EJECT button is pressed, press the Reset button and then press the EJECT button again.
- CD-R/RW: Quality of the blanks can & do effect the general operation of the CD player.
- After market CD-R/RW labels: The quality of these labels vary greatly, and can result in difficulties ejecting a disc using such labels.

Specifications

ENGLISH

GENERAL

Dimensions	: Approx. 178 mm × 50 mm × 155 mm (W × H × D)
Power requirements	: 12 volts DC car battery (negative ground)
Output Power	: RMS and Peak Power ratings (188 watts) 23 watts RMS/47 peak × 4ch
Output Wiring	: Floating-ground type designed for 4 speaker use. RCA low-level outputs (2 channels). Compatible with 4-8 ohm speakers.
Output Impedance	: 4 V.
Low - Level Output	: Frequency response : 11Hz - 100KHz
AUX Input	: Input Sensitivity : 630mV

TUNER

Tuning Range	: AM : 530 - 1,710 KHz (10 KHz step) FM : 87.5 - 107.9 MHz (200 KHz step)
Sensitivity	: AM : 20 μ V FM : 9.1 dBf mono sensitivity
FM	
Stereo Separation	: 40 dB

CD PLAYER

Frequency Response	: 20 - 20,000 Hz
S/N Ratio	: 98 dB
Wow & Flutter	: Below the measurable limit

MP3 PLAYER

MP3 decoding	: MPEG 1 Audio Layer 3
FORMAT	: ISO9660
Capability (Disk)	: 700MB